

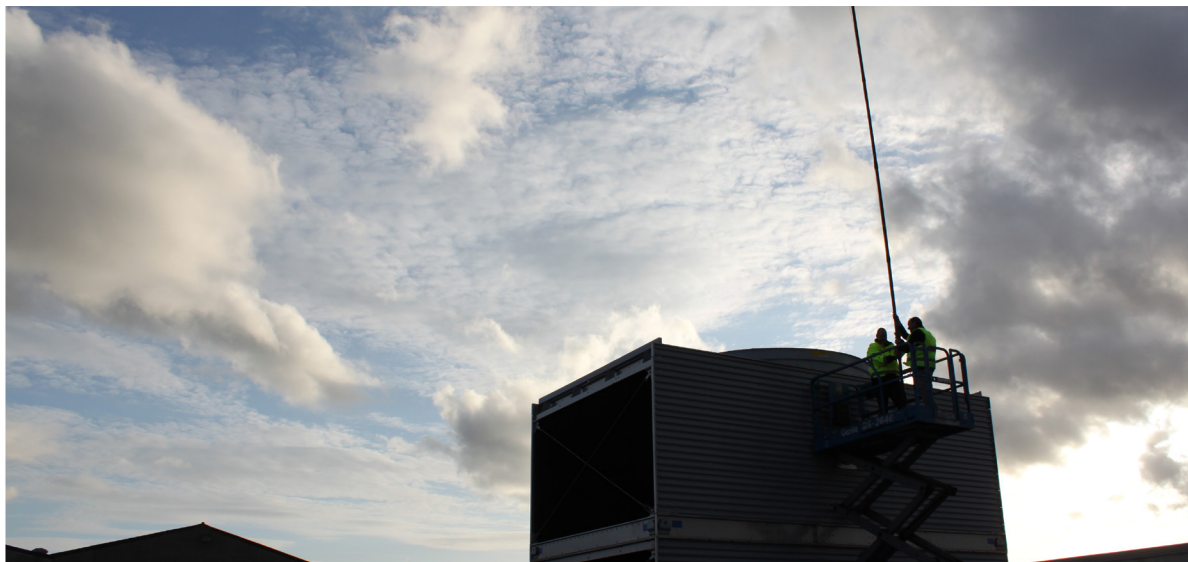

BALTIMORE
AIRCOIL COMPANY

Fundamentals of Sound



BLUE by nature
GREEN at heart



Table of contents

1	Introduction.....	3
2	Sound Levels.....	4
3	Terminology and Units of Measurement.....	5
4	Establishing the Noise Criteria.....	6
5	Sound Levels for Cooling Equipment.....	14
6	Comparison of Noise Criteria and Evaporative Cooling Equipment Sound Levels.....	22
7	Cooling Equipment Sound Control.....	25
8	Summary.....	28
	Appendix A.....	29
	Appendix B.....	30
	Appendix C.....	32
	Appendix D.....	33

1 Introduction

Sound is an important consideration in the selection of mechanical equipment. The purpose of this article is to present a procedure for evaluating the sound levels created by cooling equipment to determine if these levels will be acceptable to the neighbors* who live or work near the installation. In addition, sound levels must comply with local code requirements. While most often these levels are found to be acceptable, certain situations may call for sound levels lower than those produced by the equipment. It is then the task of the manufacturer, engineer, and owner to determine the best way to decrease the sound levels for the particular installation. This article presents a means for assessing the impact of the evaporative cooling equipment's sound on a neighbor and possible means to reduce that impact should it be a potential problem.

The procedure consists of three steps, followed by a fourth step if necessary:

1 Establish the noise criteria for the equipment: i.e., determine the sound levels that will be considered acceptable by the neighbors who will be exposed to them. Also consult local codes for appropriate sound levels. For a general idea of how sound levels produced by a cooling tower compare to sound from other common sound sources, see the graph below.

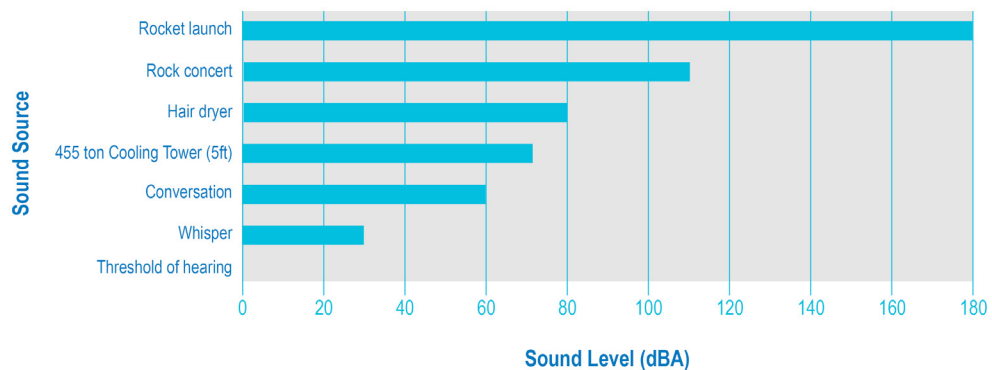

2 Estimate the sound levels that will be produced by the equipment, taking into account the effects of equipment geometry, the installation, and the distance from the equipment to the neighbor.*

3 Compare the noise criteria with the expected sound levels to determine if the sound levels from the equipment will be acceptable.

4 In the event that the equipment sound levels are excessive for the particular site conditions, a method should be determined to modify the neighbor's perception of the sound. There are three ways to change the effects that any undesirable sound has on the receiver of that sound:

- Modify the source of the sound
- Control the path of the sound
- Adjust the receiver's expectation or satisfaction, keeping in mind that sound can be very subjective and is highly dependent on perception.

* In this article, the term "neighbor" is used to denote the person or group of persons to be protected against excessive sound levels created by the evaporative cooling equipment. It is intended that this include not only the occupants of other buildings, but also the occupants of the building served by the equipment.

Some ways that sound from BAC equipment can be adjusted for a more favorable impact on the receiver include:

- Modify equipment location, position or orientation
- If possible, simply do not run the equipment at the critical time (at night for residential areas and during the day for office parks)
- Install a VFD, a second motor or a two-speed motor, so that the unit can run at lower speeds when the full capacity is not required
- Use a low sound fan or even a Whisper Quiet fan
- Oversize the equipment and run the fan at lower speed and power level
- Construct sound barriers (sound walls, etc.) or use existing barriers (trees, other buildings, etc.) when planning the location of the equipment
- Install sound attenuation (available on the air intake and air discharge of the equipment)

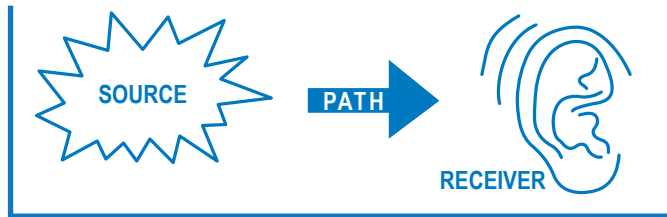

The article also includes several appendices to lend assistance in understanding and performing some aspects of a sound analysis. Contact your local BAC Balticare Representative with questions on sound analysis or sound issues specific to your installation.

2 Sound Levels

Sound rating data are available for all BAC models. When calculating the sound levels generated by a unit, the designer must take into account the effects of the geometry of the tower as well as the distance and direction from the unit to noise-sensitive areas. Whisper Quiet fans and intake and discharge sound attenuation can be supplied on certain models to provide reduced sound characteristics. The variable frequency drives, the Baltiguard® Fan System or the two-speed motors, can also be used to reduce sound during periods of non-peak thermal loads. For more information on sound and how it relates to evaporative cooling equipment, see Section “Sound Levels for Cooling Equipment”. For detailed low sound selections, please consult your local BAC Balticare Representative.





3 Terminology and Units of Measurement

The following terms and units of measure are used in this article, in accordance with accepted European Standards:

Decibel (dB) – the unit of measurement used in sound control (dimensionless, used to express logarithmically the ratio of a sound level to a reference level).

dB(A) – the A-weighted sound pressure level.

Cooling equipment – used in this article to represent all BAC product lines in the sound analysis (includes open cooling towers, closed circuit cooling towers, evaporative condensers and dry and adiabatic coolers).

Frequency – the number of repetitions per unit time (the unit for frequency is the Hertz (1 cycle/s)).

Hertz – abbreviated Hz, is the unit of frequency, defined as “cycles per second.”

Noise – unwanted sound.

Noise Criteria – the maximum allowable sound pressure level(s) (L_p) at a specific location. Criteria may be expressed as a single overall value or in individual octave bands. The NC values and curves are further explained in the next table.

Octave Band – a range of sound frequencies with an upper limit twice its lower limit. The bands are identified by their center frequencies (“identifying frequencies”), which is the square root of the product of the upper and lower cutoff frequencies of a pass band. These center frequencies and band widths are shown in the next table. In some sound data tables, these eight octave bands are also called by their “Band Numbers;” hence, the Band Numbers are also listed as such in this article, in addition to the BAC Sound Rating Program and BAC Selection Software.

Sound – the sensation of hearing; rapid, small fluctuations to which our ears are more or less sensitive; small perturbation of the ambient state of a medium (ambient air in most cases) that propagate at a speed characteristic of the medium.

Sound Pressure Level (L_p) in dB – a ratio of a sound pressure to a reference pressure and is defined as:

$$L_p = 20 \log P / 0.0002 \text{ (dB), reference } 0.0002 \text{ microbar.}$$

The reference pressure used in this article is the long-used and accepted value of 0.0002 microbar. Another way to describe the same value, which may be used in other publications, is the value of 20×10^{-6} Pascals (N/m²).

Sound Power Level (L_w) in dB – the measure of the total acoustic power radiated by a given source and is defined by:

$$L_w = 10 \log (W / 10^{-12}) \text{ dB, reference } 10^{-12} .$$

The standard reference power used in the BAC literature is 10^{-12} watt. To eliminate any possible confusion, the reference power should always be quoted, as in “a sound power level of 94 dB reference 10^{-12} watt.”

Unit – a single cell of cooling equipment.

4 Establishing the Noise Criteria

Introduction

At the beginning of any sound analysis, it is necessary to establish the sound level at a particular site that would be considered acceptable by those who might be affected. This acceptable sound level is called the “noise criteria” for that situation, and it is important to realize that it may vary widely for different situations.

The procedure for developing the noise criteria involves consideration of the following:

- The type of activity of those people in the vicinity of the evaporative cooling equipment who will be affected
- The amount of attenuation from acoustic barriers or walls that lie between the equipment and the people who may hear it
- The outdoor background noise that might help mask the sound from the equipment

From these factors, we can arrive at the final noise criteria for the particular installation.

The noise that humans hear covers a frequency range of about 20 Hz to about 20,000 Hz. Of course, there are exceptions to this, but this range has come to be accepted for most practical purposes. Furthermore, for most engineering applications, most of this audio range is subdivided into eight frequency bands called “octave bands” which cover the range of frequency somewhat as the octaves on a piano cover the range of pitch. The eight octave bands used in this article have the following identifying center frequencies and ranges:

Band Number	Identifying Frequency (Hz)	Approx. Frequency Range (Hz)
1	63	44-88
2	125	88-176
3	250	176-353
4	500	353-707
5	1000	707-1414
6	2000	1414-2828
7	4000	2828-5656
8	8000	5656-11312

When sound levels are plotted on a graph, they are most often divided into these eight octave bands. In this way it is possible to observe the variation of a sound level with change in frequency. This variation is important in any situation since humans display a different sensitivity and a different response to low frequency sounds as compared with high frequency sounds. In addition, engineering solutions for low frequency sound issues differ markedly from those for high frequency sound issues.



Indoor Neighbor Activity

From earlier studies of real-life situations where people have judged sounds all the way from “comfortable” to “acceptable” to “disturbing” and even to “unacceptable” for various indoor working or living activities, a series of “Noise Criteria Curves” (“NC” curves) has been developed. Figure 1 is a graph of these “NC” curves. Each curve represents an acceptable balance of low frequency to high frequency sound levels for particular situations, and is keyed into the listening conditions associated with the sound. The lower NC curves describe sound levels that are quiet enough for resting or sleeping or for excellent listening conditions, while the upper NC curves describe rather noisy work areas when even conversation becomes difficult and restricted. These curves may be used to set desired sound level goals for almost all typical indoor functional areas where some acoustic need must be served.

Note that the curves of the following figure have as their x-axis the eight octave frequency bands; and as their y-axis, sound pressure levels given in decibels (dB) relative to the standard reference pressure of 0.0002 microbar. For convenience, the following table lists the sound pressure levels at each octave band center frequency, for each Noise Criteria.

Table A: Octave Band Sound Pressure Levels (dB re 0.0002 microbar) of Indoor Noise Criteria (‘NC’) Curves of Figure 1

Noise Criteria	Octave Band Center Frequency in Hz							
	63	125	250	8500	1000	2000	4000	8000
NC-15	47	36	29	22	17	14	12	11
NC-20	51	40	33	26	22	19	17	16
NC-25	54	44	37	31	27	24	22	21
NC-30	57	48	41	35	31	29	28	27
NC-35	60	52	45	40	36	34	33	32
NC-40	64	56	50	45	41	39	38	37
NC-45	67	60	54	49	46	44	43	42
NC-50	71	64	58	54	51	49	48	47
NC-55	74	67	62	58	56	54	53	52
NC-60	77	71	67	63	61	59	58	57
NC-65	80	75	71	68	66	64	63	62

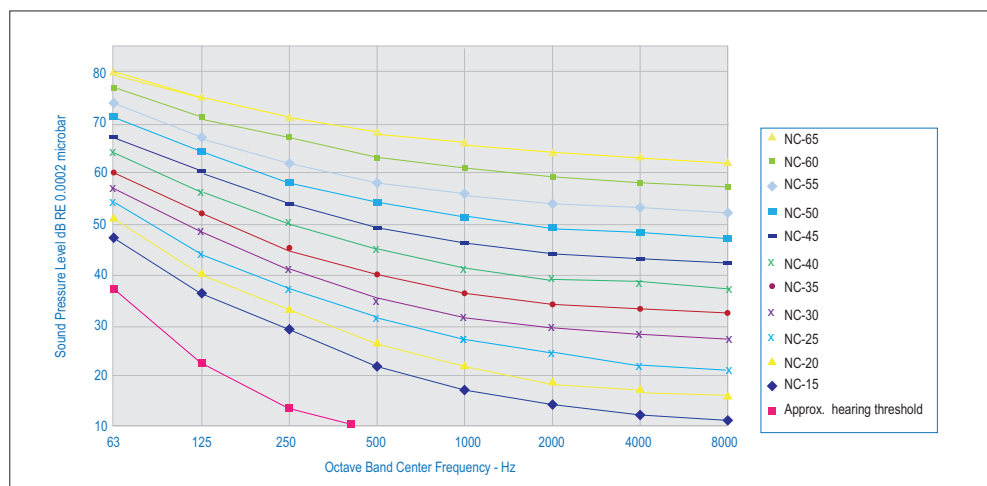

Figure 1: Noise criteria “NC” curves. The octave band sound pressure levels associated with the noise criteria conditions of Table B.



Table B is used with the NC curves and lists some typical activities that require indoor background sound levels in range of NC-15 to NC-55. Certain unusual acoustical requirements may not easily fall into one of the Table B groups. It may be necessary to apply specific criteria for those special situations or to assign a criteria based in similarity to one of the criteria given in the table.

It is emphasized that the NC curves are based on, and should be used only for, indoor activity.

The first step in the development of the evaporative cooling equipment’s noise criteria is to select from Table B the particular activity that best describes what the indoor “neighbors” in the vicinity of the equipment will be doing when the equipment is operating. Where two or more neighbor conditions may be applicable, the one having the lowest NC value should be selected. The corresponding NC values of the above figure or table A give the eight octave band sound pressure levels, in decibels, for that selection. The goal is to keep the sound heard by the neighbor, inside his home or building, at or below these sound pressure levels.

*Table B: Suggested Schedule of Noise Criteria for Indoor Neighbor Activities**

ACTIVITY	SUGGESTED RANGE OF NOISE CRITERIA
Sleeping, Resting Relaxing	
Homes, apartments, hotels, hospitals, etc. Suburban and rural Urban	NC-20 to NC-25 NC-25 to NC-30
Excellent Listening Conditions Required	
Concert Halls, recording studios, etc.	NC-15 to NC-20
Very Good Listening Conditions Required	
Auditoriums, theaters Large meeting and conference rooms	NC-20 to NC-25 NC-25 to NC-30
Good Listening Conditions Required	
Private offices, school classrooms, libraries, small conference rooms, radio and television listening in the home, etc.	NC-30 to NC-35
Fair Listening Conditions Desired	
Large offices, restaurants, retail shops, and stores, etc.	NC-35 to NC-40
Moderately Fair Listening Conditions Acceptable	
Business machine areas, lobbies, cafeterias, laboratory work areas, drafting rooms, satisfactory telephone use, etc.	NC-40 to NC-45
Acceptable Working Conditions with Minimum Speech Interference	
Light to heavy machinery spaces, industrial areas, commercial areas such as garages, kitchens, laundries, etc.	NC-45 to NC-55

* The ASHRAE Guide usually lists a 10 dB range of NC values for each situation leaving it to the option of the user to select the specific NC value for his own need. In the interest of more assuredly achieving satisfactory neighbor conditions, Table B listings are the more conservative lower 5 dB range of the ASHRAE value.



Sound Reduction Provided by Building Construction

Neighbors who are either indoors in their own building or outdoors on their property may hear sound from outdoor equipment. If they are outdoors, they may judge the sound against the more-or-less steady background sounds in the area. If they are indoors, they may tend to judge the sound by whether it is audible or identifiable or intrusive into the surroundings.

When outdoor sound passes into a building, it suffers some reduction, even if the building has open windows. The actual amount of sound reduction depends on building construction, orientation, wall area, window area, open window area, interior acoustic absorption, and possibly some other factors. The approximate sound reduction values provided by several typical building constructions are given in the following table.

For convenience in identification, the listed wall constructions are labeled with letters A through G and are described in the notes under Table C. Note that A represents no wall, hence no sound reduction, and the use of A indicates that the selected NC curve would actually apply in this special case to an outdoor activity, such as for a screened-in porch, an outdoor restaurant, or an outdoor terrace.

By selecting the wall construction in the following table, which most nearly represents that of the building containing the neighbor activity, and adding the amounts of sound reduction from Table C to the indoor NC curves, band-by-band, the outdoor sound pressure levels that would yield the desired indoor NC values when the equipment sound passes through the wall and comes inside, are obtained. This second step, then, provides a “tentative outdoor noise criteria” based on hearing the sound indoors in the neighbor’s building.

Table C: Approximate Sound Reduction (in dB) Provided by Typical Exterior Wall Construction

Octave Frequency Band (Hz)	Wall Type (See Notes Below)						
	A	B	C	D	E	F	G
63	0	10	13	19	14	24	32
125	0	10	14	20	20	25	34
250	0	10	15	22	26	27	36
500	0	10	16	24	28	30	38
1000	0	10	17	26	29	33	42
2000	0	10	18	28	30	38	48
4000	0	10	19	30	31	43	53
8000	0	10	20	30	33	48	58

A: No wall; outside conditions

B: Any typical wall construction, with open windows covering about 5% of exterior wall area

C: Any typical wall construction, with small open-air vents of about 1% of exterior wall area, all windows closed

D: Any typical wall construction, with closed but operable windows covering about 10%-20% of exterior wall area

E: Sealed glass wall construction, 6 mm thickness over approximately 50% of exterior wall area

F: Approximately 100 kg/m² solid wall construction with no windows and no cracks or openings

G: Approximately 250 kg/m² solid wall construction with no windows and no cracks or openings

Outdoor Background Sound

In a relative noisy outdoor area, it is possible that the outdoor background sound is even higher than the “tentative outdoor noise criteria.” In this case, the steady background sound in the area may mask the sound from the evaporative cooling equipment and take over as the controlling outdoor noise criteria. Determining whether or not this situation does exist is the third step in developing the noise criteria.

The best way to judge this is to take a few sound pressure level measurements to get the average minimum background level during the quietest intervals in which the equipment is expected to operate, or during the intervals when noise complaints are most likely to be caused; for example, at night in residential areas where cooling equipment is operating at night, or during the day in office areas exposed to daytime cooling equipment sound.

In the event that background sound measurements cannot be made, Tables D and E and Figure 2 may be used to estimate the approximate outdoor background noise. In Table D, the condition should be determined that most nearly describes the community area or the traffic activity in the vicinity of the evaporative cooling equipment during the quietest time that the equipment will operate. For the condition selected, there is a curve in Figure 2 that gives an estimate of the average minimum outdoor background sound pressure levels. The sound pressure levels of that figure’s curves are also listed in the table thereafter.

It is cautioned that these estimates should be used only as approximations of background sounds, and that local conditions can give rise to a wide range of actual sound levels.





Table D: Estimate of Outdoor Background Sounds Based on General Type of Community Area and Nearby Automotive Traffic Activity

CONDITION	CURVE No in FIGURE 2 or TABLE 5
1. Nighttime, rural; no nearby traffic of concern	1
2. Daytime, rural; no nearby traffic of concern	2
3. Nighttime, suburban; no nearby traffic of concern	2
4. Daytime, suburban; no nearby traffic of concern	3
5. Nighttime, urban; no nearby traffic of concern	3
6. Daytime, urban; no nearby traffic of concern	4
7. Nighttime, business or commercial area	4
8. Daytime, business or commercial area	5
9. Nighttime, industrial or manufacturing area	5
10. Daytime, industrial or manufacturing area	6
11. Within 100 m of intermittent light traffic	4
12. Within 100 m of continuous light traffic	5
13. Within 100 m of continuous medium-density traffic	6
14. Within 100 m of continuous heavy-density traffic	7
15. 100 to 300 m from intermittent light traffic	3
16. 100 to 300 m from continuous light traffic	4
17. 100 to 300 m from continuous medium-density traffic	5
18. 100 to 300 m from continuous heavy-density traffic	6
19. 300 to 600 m from intermittent light traffic	2
20. 300 to 600 m from continuous light traffic	3
21. 300 to 600 m from continuous medium-density traffic	4
22. 300 to 600 m from continuous heavy-density traffic	5
23. 600 to 1200 m from intermittent light traffic	1
24. 600 to 1200 m from continuous light traffic	2
25. 600 to 1200 m from continuous medium-density traffic	3

(Determine the appropriate conditions that seem to best describe the area in question during the time interval that is most critical, i.e., day or night. Then refer to corresponding Curve No. in Figure 2 or Table E for average minimum background sound levels to be used in sound analysis. Use lowest Curve No. where several conditions are found to be reasonably appropriate.)

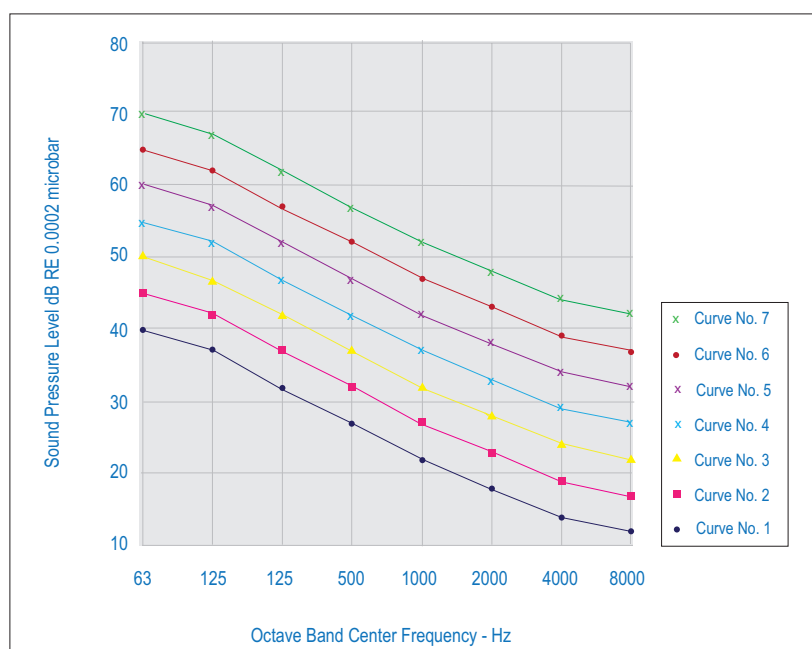

Figure 2: Approximate average minimum outdoor background sound pressure levels associated with the conditions of table D.

Table E: Octave Band Sound Pressure Levels (in dB) of Outdoor Background Noise Curves of the figure above

CURVE No. in FIGURE 2	OCTAVE BAND CENTER FREQUENCY In Hz							
	63	125	250	500	1000	2000	4000	8000
1	40	37	32	27	22	18	14	12
2	45	40	37	32	27	23	19	17
3	50	47	42	37	32	28	24	22
4	55	52	47	42	37	33	29	27
5	60	57	52	47	42	38	34	32
6	65	63	57	52	47	43	39	37
7	70	67	62	57	52	48	44	42



Final Noise Criteria

The measured or estimated average minimum background sound levels should now be compared, band-by-band, with the “tentative outdoor noise criteria” determined previously. The larger of these values, in each frequency band, now becomes the octave band sound pressure levels that comprise the “final outdoor noise criteria” for the equipment installation.

Any new intruding sound is generally judged in comparison with the background sound that was already there. If the new sound stands out loudly above the existing sound, the neighbors will notice it, be disturbed by it, and object to it. On the other hand, if the new sound can hardly be heard in the presence of the old sound, it will pass relatively unnoticed. Therefore, if the sound coming from the equipment is below or just equal to the final noise criteria, it will not be noticed and our objectives will have been satisfied.

If there are two or more different criteria for a particular installation, the analysis should be carried out for each situation and the lowest final criteria should be used.

Municipal Codes and Ordinances

Where local sound codes or ordinances exist, it is necessary to check the expected sound levels of the unit to be installed, including any sound control treatments, to determine if they comply with the code requirements. Depending on the form and language of the code, it may be necessary to introduce the code sound levels into the noise criteria analysis.



Example

To summarize this procedure, consider a cooling tower installation located near the edge of a college campus, approximately 91 m from a classroom building. The college is located within a large city, and two main streets pass by one corner of the campus about 450 m from the classroom building. The cooling tower will be used both day and night during warm weather. The classroom must rely on open windows for air circulation. Determine the noise criteria for the cooling tower.

The steps for this example are given in the sample Sound Evaluation Work Sheet, included as Appendix C in this article.

Step 1 Determine the neighbor activity condition from Table B. For “good listening conditions” inside a typical classroom, select NC-30 as the noise criteria.

Step 2 In the indicated spaces under Item 2 of the Sound Evaluation Work Sheet, enter the sound pressure levels for the octave frequency bands of the NC-30 curve as taken from Figure 1 or Table A.

Step 3 Determine the wall condition of Table C that best describes the exterior wall of the classroom. Wall B can be selected for normally open windows during the summer time. Insert the Wall B values in the Item 3 spaces.

Step 4 Add the values of Steps 2 and 3 together and insert the sums in the Item 4 spaces. This is the “tentative outdoor noise criteria.”

Step 5 In the Item 5 spaces, enter either the measured average minimum background sound pressure levels or the estimated background levels obtained from the use of Figure 2 and Tables D and E. In this example, we estimate that the traffic activity is best represented by “305 m - 610 m from continuous heavy-density traffic.” This leads to Curve 5 of Figure 2 and Table E, whose values are then inserted in the Item 5 spaces.

Step 6 In the Item 6 spaces insert the higher value, in each frequency band, of either the Item 4 or Item 5 values. This is the “final noise criteria.”

In this example, note that the Item 4 values are equal to or higher than the Item 5 values in all bands. Thus, the final noise criteria is based essentially on the classroom noise criteria and the wall condition. However, the outdoor background noise estimate equals the “tentative outdoor noise criteria” in the 250 and 500 Hz bands. If they had been higher, in this example, those higher values would have been used in setting the final noise criteria in those bands.

We will attempt to keep all octave band sound pressure levels of the selected cooling tower equal to, or below, the values of Step 6. Should a sound code exist, this would be an appropriate point in the analysis to check agreement between the code and the Step 6 final outdoor noise criteria. If the criteria developed here is lower than the sound code levels at the specified distance, the sound analysis will yield results that will comply with the code.

The remaining steps of this sound evaluation example are explained in later sections of this article as we progress with the entire sound evaluation procedure.

5 Sound level for Cooling Equipment

Introduction

Now that we have established an acceptable noise criteria, the next step is to study the source of the sound and develop equipment sound levels at the neighbor location, in the same sound pressure level terms used to express the noise criteria. It will be the aim of this section to discuss the actual sound pressure levels of BAC evaporative cooling equipment, and to show how these levels can be corrected for various distances and certain geometric arrangements. The orientation of the equipment and distance from the equipment to the most “critical neighbor” will be our primary concern. Where possible, the distance from the equipment to the neighbor should be kept as large as possible, and the equipment should be oriented so that its lowest sound levels are radiated toward the neighbor.

Cooling equipment sound ratings can be stated in terms of both sound pressure levels and sound power levels, and both may be necessary to permit thorough sound analysis in a given situation. However, in any sound evaluation, octave band sound pressure levels for the proposed equipment are essential, and it is important to have a fairly accurate indication of the directivity characteristics of the equipment’s sound.

For general use, sound pressure levels measured in the four different horizontal directions (one from each side) of the unit, plus the vertical direction above, will yield the desired directivity data. The primary requirements for obtaining the outdoor equipment’s sound levels are:

- Accurate calibrated sound measurement equipment should be used.
- Octave band sound pressure levels are mandatory.
- The sound level data should indicate the true directivity effects of the unit’s sound (there should be no nearby buildings or obstructions to distort the true radiation pattern of the unit test).
- The measurement distance should be specified.

Some equipment is rated in terms of the total sound power radiated, expressed as sound power level. Sound power level is a valid index for comparing the sum of sounds radiated by evaporative cooling equipment, but has the serious disadvantage of not revealing the directivity effects of the radiated sounds. Where only sound power level data are given, the resulting conversion to sound pressure level at a particular location will give less accurate results than if directional sound pressure level data are used. Sound generated by evaporative cooling equipment is directional, and sound pressure level ratings are necessary in order to determine the actual sound in any direction around the installation.

Single Number Rating System

Many attempts have been made to express the frequency content and pressure level (intensity) of sounds using a single number system. The most common method used is the A-B-C weighting network of sound level meters.

Sound meters with A-B-C weighting networks attempt to simulate the ear’s response to sound at different pressure intensities. At a relatively low sound pressure level, the human ear is considerably more sensitive to high frequency than to low frequency sounds. This difference, however, becomes less noticeable at higher sound levels where the ear approaches more nearly equal sensitivity for low frequency and high frequency sounds.



The A-scale weighting network is designed to simulate the ear's response for low pressure sounds (below about 55 dB).

The B-scale weighting is designated to simulate the ear's response for medium pressure sounds (about 55 dB to 85 dB).

The C-scale weighting tends to provide nearly equal response in all frequencies and is used to approximate the ear's response at higher sound pressure levels (above about 85 dB).

Octave Frequency Band (Hz)	Correction for A weighting
63	-26
125	-16
250	-9
500	-3
1000	0
2000	+1
4000	+1
8000	-1

A-B-C scale ratings have been used in some sound ordinances and equipment sound ratings because of their simplicity of statement. They may have value in some sound comparison situations, but such data are of little value in making an engineering evaluation of a sound issue caused by evaporative cooling equipment, because no indication of the frequency content of the sound is apparent. For example, two different types of cooling towers could have the same A scale rating, but one could have most of its energy in the low frequency bands while the other could have its energy concentrated in the high frequency bands. A single number rating will give no indication of this and its use could lead to less than optimal and sometimes costly decisions.

Comparison of Cooling Equipment employing a Centrifugal Fan versus an Axial Fan

Based on extensive studies of field data from several cooling tower installations, it has been found that overall sound pressure levels of centrifugal fan cooling towers are about 5 to 7 dB lower than those of axial fan cooling towers for the same cooling capacity even though the axial towers use about half the kW. As a comparison, this means that an axial fan cooling tower would have to be twice as far away from the neighbors as a centrifugal fan tower in order to be just as quiet (6 dB reduction for each doubling of distance, see Table F). The frequency distribution and the radiation patterns also differ for these two types of units. For any specific comparison of cooling towers, the manufacturer's actual measured data should be used.

BAC Sound Ratings

BAC has measured the sound levels radiated by its products at 1,5 m and 15 m distances for the five principle directions, (four horizontal and one vertical). The sample sound rating data sheet indicates the five principle directions and the type of sound data available for a BAC cooling tower. As the data sheet suggests, the data given in the five blocks pertain to the sound pressure levels measured at 15 m distances from the five principle directions of the cooling tower. Where it might be desired to estimate the sound pressure levels at some intermediate direction, such as halfway between the right end and the air inlet, levels can be averaged or interpolated from the data actually presented.



Sound Rating

Sound Pressure Level					
Hz	Fan End(dB)	Back(dB)	End1(dB)	End2(dB)	Discharge (dB)
63	66.0	60.0	64.0	64.0	58.0
125	64.0	58.0	61.0	61.0	60.0
250	61.0	54.0	56.0	56.0	58.0
500	58.0	54.0	54.0	54.0	57.0
1000	58.0	53.0	52.0	52.0	56.0
2000	55.0	48.0	48.0	48.0	53.0
4000	52.0	43.0	42.0	42.0	49.0
8000	49.0	38.0	38.0	38.0	44.0
dB(A)	63.0	57.0	57.0	57.0	61.0

Input Options	
Model	VXT 185
Sound Attenuation	no attenuation
Additional ESP (Pa)	0
Fan Motor Size (kW)	1 x 18.5 kW
Approximate Fan Speed	100.0 %
Distance (m)	15.0

Total Sound Power Level	
Octave Band (Hz)	Total Sound Power Level
63	95.0
125	93.0
250	90.0
500	88.0
1000	87.0
2000	83.0
4000	80.0
8000	76.0
dB(A)	91.0

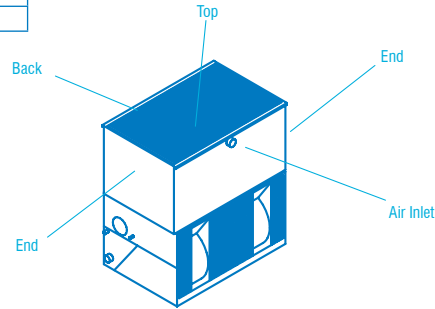

Octave band and A-weighted Sound Pressure Levels (SPL) in dB RE 0.0002 Microbar.
 Note: Sound data are free field data valid for unit installation without elevation, not taking into account any reflections

BALTIMORE AIRCOIL COMPANY

In addition to the five sets of sound pressure levels at each of the two distances, the data sheets contain the calculated sound power level values for the reference power level 10-12 watt. Current sound data for all BAC equipment is available from BAC Balticare Representative.

Since sound power levels are being mentioned here, it is appropriate at this point to note that Appendices A and B are given at the end of this article to supply basic information related to sound power levels and to other calculations that may be required from time to time in a sound evaluation. Appendix A describes the required method according the CTI 128 standard for calculating the sound power level of a unit where the five sets of sound pressure level readings are known.

Effective Distance beyond 15 m

In any actual situation, it is usually necessary to determine the sound pressure levels of the equipment at some distance other than the 1,5 m and 15 m distances given in the BAC rating sheets. In this section, distance corrections are given for estimating sound pressure levels at distances beyond 15 m.

For distances that are large compared to the dimensions of the unit, the “inverse square law” holds for sound reduction with distance: i.e., for each doubling of distance from the unit, the sound pressure level decreases 6 dB. Thus, for distances beyond 15 m the inverse square law applies and the distance correction is quite straightforward. Table F presents the reduction of sound pressure level for distances from 15 m out to 800 m. The values given in Table F are to be subtracted from the sound pressure levels at the given distance of 15 m in order to arrive at the sound pressure levels at the distance of interest.



For relatively short distances (less than 30 m), the same correction value applies to all eight frequency bands. For the larger distances (greater than 30 m), high frequency sound energy is absorbed in the air and the correction terms have larger values in the high frequency bands. For distances greater than about 150 m, wind and temperature of the air may further influence sound propagation; but because these are variables, they are not considered in this article and the correction figures of Table F represent more or less “average” sound propagation conditions.

If the critical distance falls between the specific distances given in the left-hand column of Table F, interpolate the sound reduction value to the nearest 1 dB. Do not attempt to use fractions of decibels.

Table F: Reduction of Sound Pressure Level (in dB) for Distances beyond 15 m

Distance (m)	Octave Band Center Frequency in Hz							
	63	125	250	500	1000	2000	4000	8000
15	0	0	0	0	0	0	0	0
20	2	2	2	2	2	2	2	2
25	4	4	4	4	4	4	4	4
30	6	6	6	6	6	6	7	7
37,5	8	8	8	8	8	8	9	10
50	10	10	10	10	10	10	11	12
60	12	12	12	12	12	13	14	15
75	14	14	14	14	14	15	16	18
100	16	16	16	16	16	17	18	21
120	18	18	18	18	19	19	21	24
150	20	20	20	20	21	22	24	27
200	22	22	22	22	23	24	27	31
240	24	24	24	25	25	26	30	35
300	26	26	26	27	27	29	34	40
400	28	28	28	29	30	32	38	46
480	30	30	30	31	32	35	43	53
600	32	32	32	33	35	38	47	61
800	34	34	34	36	38	42	53	70

Effect Distance between 1,5 m and 15 m

In this section, distance corrections are given for estimating sound pressure levels in the close-in range of 1,5 m to 15 m. When the distance from a sound source is small or comparable to the dimensions of the source, the “inverse square law” does not necessarily hold true for variations of sound level with distance. So, for the relatively short distances of 1,5 m to 15 m, it might be necessary to accept some sound pressure level variations, which do not follow the straightforward trends that hold for distances beyond 15 m. Table G permits us to estimate the sound pressure levels at these close-in distances, provided the 1,5 m and 15 m sound pressure levels are known.

To illustrate the use of Table G, suppose the sound pressure level of a unit in a particular frequency band is 68 dB at 1,5 m and 54 dB at 15 m distance. The difference between these two values is 14 dB. In Table G, we find the column of values under the heading “If the difference between the 1,5 m and 15 m levels is 13 – 15 dB.” The numbers in this column are the values (in decibels) to be added to the 15 m sound pressure level of 54 dB to obtain the sound pressure level at some desired shorter

distance. If, for instance, we wish to know the “sound pressure level” of this unit at 1,5 m, we find that we must add 8 dB to the 15 m level of 54 dB to get 62 dB as the sound pressure level at the desired distance of 1,5 m.

Now, for these close distances, the difference values between the 1,5 m and 15 m sound pressure levels may not be constant for all frequency bands so it is necessary to follow this procedure for each octave band. For example, in one frequency band the difference may be 12 dB but in another band it may be 15 or 16 dB.

Close-in interpolation of sound pressure levels is inherently somewhat unreliable; so do not be surprised if some oddities or discrepancies in the data begin to appear at very close distances. The method used here at least gives some fairly usable data to work with.

Table G: Interpolation Terms for Obtaining Sound Pressure Levels (in dB) Between 1,5 m and 15 m

Distance at which SPL is desired (m)	If the difference between the 5ft and 50 ft levels is:						
	4-6 dB	7-9 dB	10-12 dB	13-15 dB	16-18 dB	19-21 dB*	22-24 dB
	Add the following values to the 15 m sound level to obtain sound level at desired distance:						
15	0	0	0	0	0	0	0
13,5	0	0	1	1	1	1	1
12	1	1	1	2	2	2	2
10,5	1	1	2	3	3	3	3
9	2	2	3	4	4	4	5
7,5	2	3	4	5	5	6	7
6	2	4	5	6	7	8	9
4,5	3	5	6	8	9	10	12
3	4	6	8	10	12	14	16
1,5	5	8	11	14	17	20	23

* This column of values is based on the “Inverse Square Law” variation with distance from 15 m all the way in to 1,5 m. All other columns represent variations with distances that do not follow the “Inverse Square Law.”

Reflecting Walls and Enclosures

Discussion so far has been concerned with what might be considered “simple installations” from an acoustic point of view, where only distance to the neighbor and relative orientation of the unit have been required points of consideration.

Frequently, the geometry of an installation involves some nearby reflecting walls or buildings, which adds to the acoustic complexity of the site. Let us consider this for three typical situations:

- Cases in which reflecting walls modify the radiation pattern of the sound from the unit to the neighbor
- Cases in which close-in walls confine the unit and cause a build-up of close-in sound levels
- Cases in which the unit is located in a well and all the sound radiates from the top of the wall

Effect of Reflecting Walls

Several factors that influence the amount of reflected sound are the following:

- The sound radiation pattern (directivity) of the equipment
- The radiating area of the equipment
- The orientation of the equipment
- The distance of the unit to the neighbors
- The distance of the equipment to the reflecting wall
- The area of the reflecting wall
- Various angles of incidence and reflection between the equipment, the wall, and the neighbors

Because so many variables are involved, we will not attempt to develop a rigorous procedure for estimating the influence of a reflecting wall. Rather, we caution that if a large reflecting surface is located near the equipment, it should be considered as a potential reflector of sound. If the equipment is oriented such that its loudest side is already facing toward the neighbor, the influence of the reflecting wall can be ignored!

However, if this is not the case, these conditions must be met for the reflected sound to be of concern:

- The area of the reflecting wall is at least three times the area of the side of the equipment that faces that wall
- The distance from the unit to the reflecting wall is less than half the distance from the equipment to the neighbor
- If a simple optical ray diagram is drawn from the center of each unit to all parts of the reflecting wall and the reflecting rays are then drawn away from the wall, the neighbor is located within the angular range of the reflected rays (see sketch below)

If each of these three conditions is met, then the sound pressure levels at the neighbor may be higher than if the wall were not there.

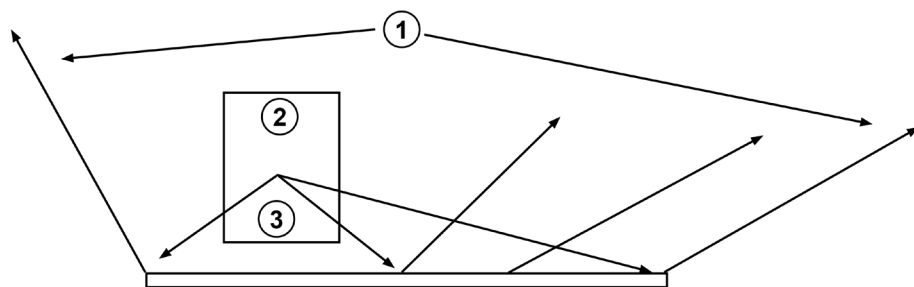

Neighbor Area Influenced by the Reflecting Wall
 1. Neighbor area influenced by the reflecting wall; 2. Cooling Tower; 3. Air Intake.

In Figures 3 and 4, a few representative reflecting walls are shown for various orientations, and approximate sound pressure level adjustments are suggested for A, B, C, and D directions away from the equipment. These adjustments should be made using the 15 m levels. Figure 3 applies to units having one air intake, while Figure 4 applies to units having two air intakes.

As an example, for Case 1, if the neighbor is located off the A side of the unit, apply the "A" adjustment to the A side 15 m sound pressure level rating of the unit and then correct as necessary to the neighbor's distance. If the situation is that of Case 9 and the neighbor is located in the direction D, then the "D" adjustment would be utilized to arrive at a 15 m sound pressure level for the unit.

Figure 3: For Single Air Inlet Units

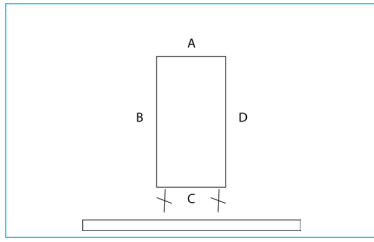

Case 1

A. Use Average of A and C Levels, B. Use average of B and C levels, C. Not applicable, D. Use average of D and C levels.

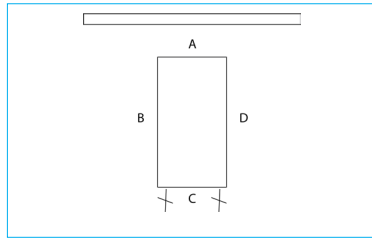

Case 2

A. Not applicable, B. Use greater of B level or average of B and A levels, C. No change to C levels, D. Use greater of D level or average of D and A levels.

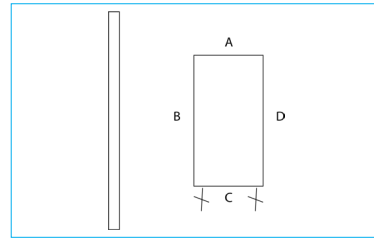

Case 3

A. Use greater of A level or average of A and B levels, B. Not applicable, C. No change to C levels, D. Add 2 dB to D levels.

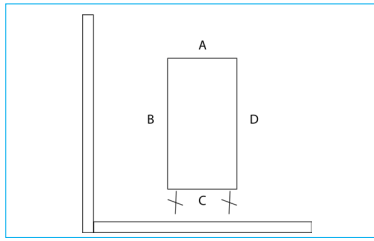

Case 4

A. Use average of A and C levels, B. Not applicable, C. Not applicable, D. Use average of D and C levels.

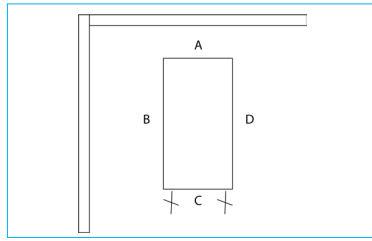

Case 5

A. Not applicable, B. Not applicable, C. No change to C levels, D. Use average of A, C, D levels.

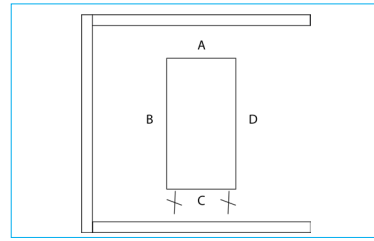

Case 6

Four sound levels out the open end of a 3-sided enclosure, add 3 dB to the sound pressure levels of the air intake side of the unit.

Figure 4: For Dual Air Inlet Units

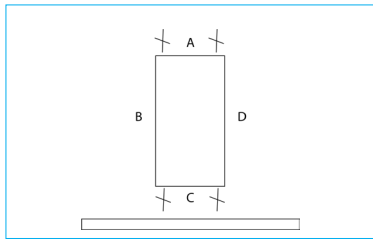

Case 7

A. Add 2 dB to A levels, B. Use average of B and C levels, C. Not applicable, D. Use average of C and D levels.

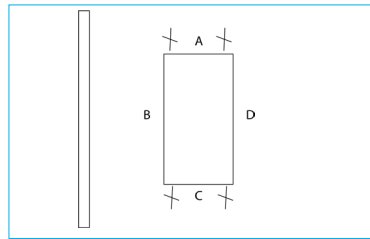

Case 8

A. No change to A levels, B. Not applicable, C. No change to C levels, D. Add 3 dB to D levels.

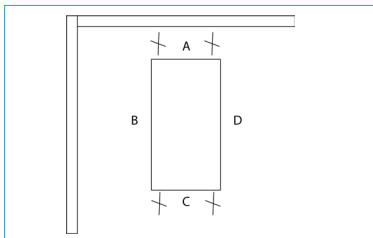

Case 9

A. Not applicable, B. Not applicable, C. Add 2 dB to C levels, D. Add 3 dB to D levels.

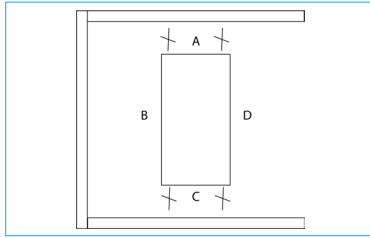

Case 10

For sound levels out the open end of a 3-sided enclosure, add 3 dB to the sound pressure levels of the air intake side(s) of the unit.

These figures and their associated adjustment values are to be used to correct base 15 m sound pressure level ratings in the neighbor direction of the effect of the reflecting surface conditions shown.



Build-Up of Close-in Sound Levels

Cooling equipment is sometimes located very close to a building wall, inside a “court” formed by two or three surrounding walls, or even in a specially provided room or space in the mechanical equipment area inside a building. In these installations, the principal concern may be the sound in the immediate vicinity (within 1,5 m - 3 m) of the unit(s), rather than the sound levels radiated and reflected away to some neighbor location.

For these situations, we may use Table G to determine approximately the sound pressure levels for the close-in distances of interest, and then add an increment to account for the build-up of sound levels. Here also, the geometry of the layout controls the problem and it is not possible to give a general solution that will cover the multitude of possible layouts. As an approximate acknowledgement of this situation, we suggest that the close-in sound pressure levels be increased by 5 dB, recognizing that the range of increase could be as little as 2 or 3 dB (in a fairly open courtyard) and as much as 10 to 15 dB (in a fairly confined mechanical room enclosure). This adjustment should be applied to all eight-octave band readings.

Sound Radiation from a Four-Sided Enclosure or “Well”

Cooling equipment is sometimes located inside a four-sided enclosure or “well,” where all the sound radiates more-or-less vertically out the top of the well and then “spills over” the sidewalls of the well. A simple generalized solution to this problem is not possible, but a reasonable approximation can be made.

While the sidewalls serve as barrier walls against normal sound radiation in horizontal directions, the four-sided enclosure tends to “average-out” any free-field directional characteristics of the unit and causes an average sound pressure level to be radiated from the top of the well in all directions in which sound is free to radiate per the geometry of the situation.

In the typical case illustrated, where the sound from the well radiates over a hemisphere, the sound pressure levels of the unit at a 15 m distance would be determined by subtracting 32 dB from the sound power levels of the unit.

It should be recognized that this method of sound evaluation is an approximation. Actual sound levels may be somewhat lower in the higher frequency bands, and could be slightly lower in the lower frequency range depending upon the neighbor location relative to the equipment. If the sidewall of the well clearly serves as a barrier wall for the radiated sound, barrier wall attenuation values can be applied to the problem in the same manner as the sound evaluation procedure of this article subsequently permits for the non-well type installation.



Example Continued

Let us now summarize Step 2 in the sound evaluation process, looking at the source of sound and correcting it for distance and path. This will yield equipment sound pressure levels for the same point, which the final noise criteria was calculated in the earlier example.

We are now interested in Items 7-11 in the sample Sound Evaluation Work Sheet (see Appendix C) which pertain to the cooling tower sound pressure levels as extrapolated to the 90 m distance. We continue the step-by-step procedure on the Sound Evaluation Work Sheet where we left off earlier.

Step 7 Decide on the preferred orientation of the cooling tower at the site. From the BAC Sound Rating Data Sheet, determine the sound pressure levels at the 15 m distance for the side of the cooling tower facing the college classroom. Assume one of the end sides here (the “blank-off sides”), since they are the quietest. Insert these sound pressure level values in the Item 7 spaces of the Sound Evaluation Work Sheet.

Step 8 Insert the distance “90” m in the appropriate space under Item 8 and refer to Table F for the distance correction values corresponding to 90 m. Insert these values in eight spaces of Item 8.

Step 9 The sound pressure levels at 90 m will be lower than at 15 m, hence subtract the Item 8 values from the Item 7 values and insert the remainder in the Item 9 spaces. These then are the sound pressure levels that will exist just outside the college classroom, 90 m from the cooling tower.

Step 10 Had there been a sound increase due to the presence of a reflecting wall that met one of the conditions illustrated by Figures 3 or 4, corrections would be inserted now in the Item 10 spaces. Had this been a close-in problem involving a build-up of sound levels due to some nearby enclosing walls around the tower, “+5 dB” would have been inserted in the Item 10 spaces. Since neither of these conditions applied in this example, we insert “0” in each of the Item 10 spaces.

Step 11 Item 11 is the sum of Items 9 and 10. This is the sound pressure level of the cooling tower at the 90 m distance.

6 Comparison of Noise Criteria and Evaporative Cooling Equipment Sound Levels

Example Continued

From the material given in the two preceding sections, it is now possible to determine if a particular cooling tower will be satisfactory (from a sound point-of-view) in a given location for a given set of circumstances. The analysis now consists of comparing the estimated cooling tower sound levels with the noise criteria developed for the neighbor situation. The comparison may be made by plotting the sound levels and the noise criteria on a graph, as show in Figure 5, or merely by comparing the two groups of values on a band-by-band basis. We are now interested in Items 12-13.



Step 12 Merely as a means of simplifying the next step, copy in the Item 12 spaces the values taken from Item 6, which was the “Final Noise Criteria.”

Step 13 By subtracting the Final Noise Criteria (Item 12) from the Resultant Cooling Tower Sound Pressure Levels (Item 11), we determine if there is any excess of cooling tower sound above the criteria. Any positive-valued remainder represents sound excess above the criteria. Any negative-valued remainder means that the cooling tower level is below the criteria and no sound reduction is required in the frequency bank; hence, “0” is inserted in that space.

If the cooling tower levels in all eight octave bands are below the criteria values, there should be no sound problem. If two or three of the cooling tower levels exceed the criteria values by only 1 or 2 or 3 dB, there will probably be no sound problem. If several octave band sound levels exceed the criteria by 5 to 10 dB, or more, a sound problem should be anticipated – the higher the sound excess the more assured is the problem if suitable measures are not taken.

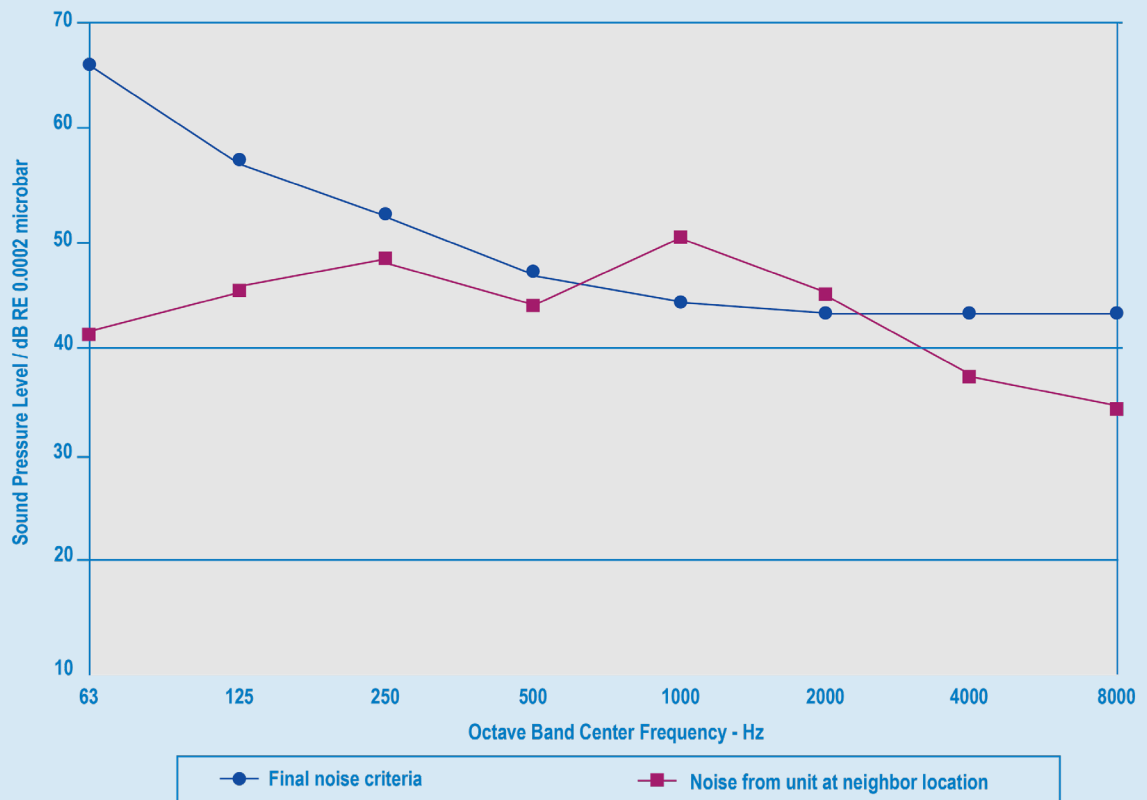

Judgement Factor

At this point, some remarks should be made on the overall reliability of this approach, and an opportunity should be provided for inserting a judgment factor. In as much as the original criteria selection was based mostly on lower range NC values for the various environments considered, the derivation presented here may be somewhat conservative. Because of this, decisions based on this approach will usually lead to acceptance of the sound from the equipment. As explained throughout the procedure, several approximations are made (such as for the sound reduction of various general types of walls, and the sound estimates of community or traffic background sounds, and others). These approximations may lead to some variability from one installation to the next, although it is believed that a small amount of variability can be accommodated by the procedure without changing the results unreasonably.

Experience shows that where the criteria is based on sleeping at night, the criteria should not be exceeded, and therefore, the conclusions reached by this procedure should be followed. However, where the criteria is based on somewhat less critical daytime activities, and the background sound frequently ranges considerably above the average minimum conditions used here, then the risk is not too great if the criteria is exceeded by about 5 dB. In such cases the criteria should not be exceeded by more than 5 dB for fear of serious objections. If it is decided to permit the sound to exceed the criteria by as much as 10 dB or more, sound reduction steps should be considered for future addition to the installation, even though they may not be included in the initial installation.

In view of the above, if the equipment's owner, architect or engineer chooses to follow a conservative approach or even to allow for some excess sound on a particular project (that is, permit the equipment's sound to exceed the background sounds slightly and thus be identifiable and possibly disturbing to the neighbors), this opportunity is afforded in Items 14 and 15 of the Sound Evaluation Work Sheet (Appendix C).

Step 14 Insert the cooling tower owner's Judgement Factor. For a "conservative approach" insert 0 dB in the Item 14 spaces of the Work Sheet. To purposely allow the cooling tower sound to exceed the acceptable levels slightly, insert 5 dB in the Item 14 spaces.

Step 15 The Final Sound Reduction Requirement for the cooling tower is the difference, in each band, obtained by subtracting Item 14 from Item 13. These are the attenuation values in each octave band necessary to reduce the cooling tower sound to an acceptable level. A brief discussion of sound control for evaporative cooling equipment is given in the next section.

Step 16 Sound reduction can be accomplished in several ways, and quantitative values for possible sound reduction steps are discussed in the next section. Step 16 of the Sound Evaluation Work Sheet should include the attenuation obtained from the use of VFD, Baltiguard drives, two-speed fan motors, low sound fans, barrier walls, and from any special acoustic treatments to be provided. Other situations that may apply are oversizing the equipment and utilizing strategic layout.





7 Cooling Equipment Sound Control

Introduction

The sound reduction required for cooling equipment is simply the excess of the equipment's sound pressure levels over the applicable noise criteria levels. This is shown numerically by the dB values found in Item 15 of the Sound Evaluation Work Sheet (Appendix C) when the particular calculation is carried out. The clue as to whether it will be a simple or complex sound reduction problem lies largely in the amount and frequency distribution of the required sound reduction.

Job conditions may allow some quieting to be obtained by strategically positioning the equipment, controlling the fan motor, installing a low sound fan option, or constructing barrier walls located between the equipment and neighbor. Additional sound reduction needs may be met with packaged attenuators or other acoustic treatments, which, in general, can achieve high frequency noise reduction rather easily but usually involve larger weight and space requirements to accomplish low frequency quieting.

Strategic Positioning

The first and most economical strategy in reducing sound pressure levels from cooling equipment involves considering the layout of the equipment. "Strategic Positioning" includes two aspects. First, make sure to position the quietest side of the equipment towards the sound sensitive direction. This option should always be a first consideration with single side air inlet products. Next, take advantage of any existing sound barriers that may aid in muffling the sound from the equipment to the neighbor. For example, if a building or shed exists on the job site, position the equipment so that the structure blocks the direct path between the equipment and the neighbor, thus acting as a sound barrier. Trees and bushes are also good examples of barriers that greatly reduce sound exposure at neighboring properties.

Fan Motor Control

Operating the equipment at various speeds by utilizing a VFD, Baltiguard drives or a two-speed motor is a practical option of sound control if reduced equipment loads can be made to coincide with periods when low sound pressure levels are required. This is a normal nighttime situation for many air conditioning installations.

An 1500-750 rpm fan motor operating at 750 rpm would provide about 60% of full-load capacity on a BAC unit and would give approximately the following octave band dB noise reductions:

Frequency Band - Hz							
63	125	250	500	1000	2000	4000	8000
4	6	8	10	8	8	6	4

In as much as these are average dB reductions that can be anticipated for half-speed operation, these figures can apply to both sound power and sound pressure levels. Also, these approximations are sufficiently accurate to be used for both centrifugal and axial fan towers.

In addition to running the equipment at a lower speed during noise-critical hours, it is beneficial to investigate whether or not the equipment could be turned off completely during these hours. This would completely negate any sound created by the unit; however, the system and its loads must be researched to understand if this option is feasible.

In some cases what people find objectionable is not the steady sound of the equipment, it is the abrupt stopping and starting of the fan system. Properly setting the tower control sequence to avoid excessive cycling of fan motors is important in this regard, as well as to protect the motor from overheating. VFD's solve this issue by allowing for a soft start of the fans, followed by a gentle ramping up and down of the fan speed in line with the load requirement. Simply stated, VFD's allow the fan motor to run at the speed required to meet leaving water temperature requirements rather than running at full speed all the time. Decreasing the motor speed, and therefore the fan rpm, can decrease sound levels significantly. VFD's also minimize harsh sounding on-off cycles by providing a gradual start.

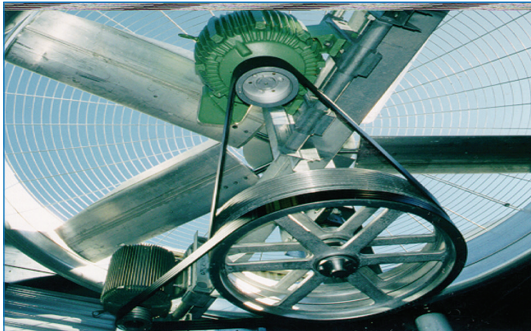

Figure 6:
BAC axial fan cooling tower utilizing the Baltiguard drive



Figure 7:
If applicable, turn towers off at night to eliminate sound



Figure 8:
VFD with Integrated Bypass



Figure 9:
Axial Fans

Oversizing Equipment

If space and budget allow, it may be beneficial to oversize the equipment and run the larger capacity equipment at a lower fan speed rated for the specific job. As discussed in the previous section, reducing the motor speed reduces the fan speed and because fan speed is directly proportional to sound, reduces sound.

Low Sound Fans

Another option for reducing the sound that the equipment produces is to select a low sound fan. Low sound fans provide greater solidity than regular fans and so are able to move the same amount of air, while operating at a slower speed.

Barrier Walls

Barrier walls can be used to provide sound attenuation. In some cases barrier walls may exist due to the architectural treatment of the site, while at other times they are constructed specifically to provide needed sound reduction.

Taking the first case, a wall used to shield a unit from view can also act to reduce the sound radiated by the tower, particularly high frequency sound (broadly considered here as the upper four octave frequency bands). However, such barrier walls must “cover” by line-of-sight the entire sound source as observed from the neighbor’s position. Louvered, latticed or slotted openings will render negligible the attenuation abilities of a barrier wall. A solid wall of height equal to a unit and located close to it will provide the following approximate attenuation:

Frequency Band - Hz							
63	125	250	500	1000	2000	4000	8000
4	5	5	5	5	6	7	8

When greater attenuation is required, a larger specially constructed barrier wall may be designed and installed. Care must be taken, though, in locating the wall because of the many geometric and material considerations involved.

As an example, a barrier wall that (1) extends at least 1 to 1,5 m beyond the line-of-sight in both the horizontal and vertical directions, (2) that is located within 1,5 to 2,5 m of the cooling tower and (3) that is made of a solid impervious material having a surface weight of at least 85 g/m² will have approximately the following attenuation:

Frequency Band - Hz							
63	125	250	500	1000	2000	4000	8000
5	5	6	8	10	12	14	16

A still larger and heavier barrier wall will provide still greater attenuation. To be most effective, however, a barrier wall must be located as close as possible to the sound source and there must be no reflecting surfaces in the area that can reflect sound around the barrier.

Design details of barrier walls and other acoustic treatment such as custom-engineered plenum chambers and acoustic mufflers are best left to acoustical engineers or consultants and acoustical treatment manufacturers.



Figure 10: Architectural walls being constructed around Closed Circuit Cooling Towers

Sound Attenuation

A significant feature of both axial and centrifugal fan equipment is that its noise, if it is a problem at all, can be treated with relatively simple package attenuation. Figure 11 is a photograph of a BAC Axial Fan Open Cooling Tower with sound attenuation on both the intake and discharge of the unit.

The fan intake attenuator has unique circular acoustical baffles in a staggered arrangement and the discharge attenuator is a lined plenum chamber.

Lined plenum chambers, to be effective, (1) must be fairly large, (2) should contain a thick absorbent lining, and (3) should be arranged such that the sound path through the plenum includes does not allow line-of sight. Depending on the degree to which the plenum chamber conforms to these three requirements, its sound reduction may range in the order of 5 to 10 dB for low frequency noise up to 10 to 20 dB for high frequency noise.



Figure 11: Intake and discharge sound attenuation on a BAC Axial Fan Open Cooling Tower

BAC sound attenuation packages are designed, tested and rated by BAC, hence ensuring single source responsibility. They provide reductions in the horizontal direction up to 25 dB in the mid frequency bands. Many sound attenuation alternatives are available from BAC to optimally and economically meet a large variety of sound requirements. Sound attenuation packages are available for centrifugal and axial fan models. Exact values of the attenuation obtained from these packages are available from your local BAC Balticare representative.

Effects of Sound Reduction Options on Equipment Performance

The cost of sound attenuation, including the effect on performance, must be evaluated versus simpler methods such as oversizing the unit(s) to meet the sound criteria for a project. Note that with either low sound fans or “add-on” attenuation, lower sound levels often come at the expense of lower airflow. The system designer must ensure that the manufacturer’s ratings are adjusted to account for any decrease in thermal performance from this reduction in airflow.

Another caution is for the use of sound barrier walls. It is necessary for barrier walls to be far enough away from the tower so as to prevent recirculation of the moist discharge air. If this practice is not followed, the warm air can be introduced to the air intake, increasing the wet bulb temperature of the unit, and in turn decreasing the cooling capacity of the tower.

8 Summary

This article provides a simple and direct evaluation method for determining whether or not a given cooling equipment installation is producing, or will produce, excess sound. It also offers some general information on methods that can be used to reduce the sound.

BAC can provide reliable sound level data on its open cooling towers, closed-circuit cooling towers, evaporative condensers, dry coolers and dry coolers with adiabatic pre-cooling through their representatives. Consult your local BAC Balticare Representative for specific project applications.

Acknowledgement:

BAC extends its sincere appreciation to **Mark E. Schaeffer, P.E.**
(President of Schaeffer Acoustics Inc. of Pacific Palisades, CA) for his contributions to this article.

The Calculation of Sound Power Level (L_w) from Measured Sound Pressure Levels (L_p) in accordance with ATC 128-2019

Sound power is a measure of the total acoustic power radiated by a sound source. “Sound power level” is the sound power, expressed in decibels, relative to the reference power quantity 10^{-12} watt.

Sound power is not directly measured as such. Instead, it is a calculated quantity and is obtained from the measurement of sound pressure levels at a suitable number of measurement positions. Even in indoor testing with reverberant or semi-reverberant rooms and a standard reference sound source, sound power level is calculated from sound pressure level measurements. In this discussion, no technical detail is given for the derivation of sound power level; instead, the required method to calculate the sound power level for factory assembled evaporative cooling equipment. Here the sound pressure level is measured at four horizontal positions (each position at a specific distance from each of the four sides) plus one vertical position above the unit.

The measured sound pressure levels must be obtained with accurate, calibrated equipment, and the sound data must be in the conventional eight octave bands of frequency. The measurements should be made under essentially free-field conditions: i.e., outside in an area free of any nearby reflecting surfaces. The unit is assumed to be located on the ground or on a platform reasonably close to ground level.

Five sound pressure levels (L_p) produced by the operating tower in each of the octave bands shall be measured at the following locations:

- Side Measurement Locations: At the lateral midpoint of each of the four sides, the sound pressure levels (L_p) shall be recorded at a distance of 15 m from the side of the unit and at an elevation of 1,5 m above the ground level.
- Overhead Measurement Location: At the geometric center of the top surface, the sound pressure levels (L_p) shall be recorded at a distance of 15 m above the top of the tower.

To establish the sound power level (L_w), the correct emission surfaces need to be calculated. For each of the four sides, this will be a quarter of a cylinder where the height corresponds with the height of the unit and the radius corresponds with the horizontal distance between the measurement point to the center of the unit. For the top, this will be a hemisphere where the radius corresponds with the vertical distance between the measurement point and the top of the unit. These surfaces are shown in the figure below.

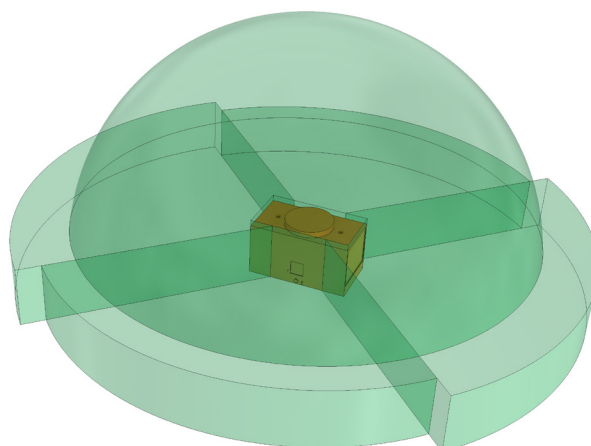

The total sound power level is the logarithmic sum of the 5 partial sound power levels, calculated as follows:

$$L_{W1} = L_{PS1} + 10\log_{10}(S1)$$

$$L_{W2} = L_{PS2} + 10\log_{10}(S2)$$

$$L_{W3} = L_{PE1} + 10\log_{10}(E1)$$

$$L_{W4} = L_{PE2} + 10\log_{10}(E2)$$

$$L_{W5} = L_{PS3} + 10\log_{10}(S3)$$

$$L_W = 10\log_{10} \sum_{i=1}^5 10^{L_{Wi}/10}$$

Where:

L_{PS1} = Sound pressure @ 15m associated with emission area S1

L_{PS2} = Sound pressure @ 15m associated with emission area S2

L_{PE1} = Sound pressure @15m associated with emission area E1

L_{PE2} = Sound pressure @15m associated with emission area E2

L_{PS3} = Sound pressure @15m associated with emission area S3

L_{W1} = Sound power associated with emission area S1

L_{W2} = Sound power associated with emission area S2

L_{W3} = Sound power associated with emission area E1

L_{W4} = Sound power associated with emission area E2

L_{W5} = Sound power associated with emission area S3

L_W = Total sound power of the unit

S1 & S2 = Cylindrical emission surface area associated with sides of the unit (m²)

E1 & E2 = Cylindrical emission surface area associated with ends of the unit (m²)

S3 = Hemispherical area above the unit





Appendix B

Addition of Decibels

Since decibels are logarithmic values it is not proper to add them by normal algebraic addition. For example, 63 dB plus 63 dB does not equal 126 dB but only 66 dB.

A very simple, but adequate schedule for adding decibels is as follows:

When two decibel values differ by:	Add the following amount to the higher value:
0 or 1 dB	3 dB
2 or 3 dB	2 dB
4 or 8 dB	1 dB
9 dB or more	0 dB

When several decibel values are to be added, perform the above operation on any two numbers at a time, the order does not matter. Continue the process until only a single value remains. As an illustration let us add the five sound levels used in the example of Appendix B.

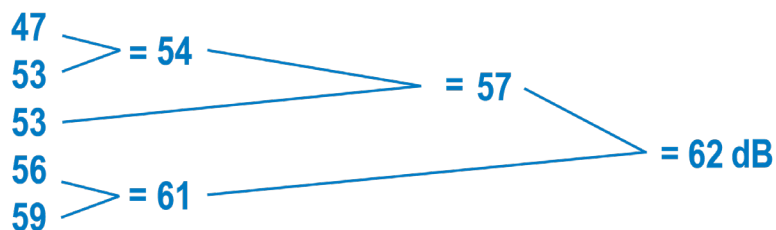

Or, suppose we arrange the same numbers in a different order, as in:

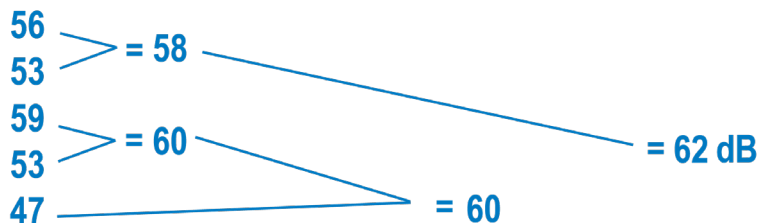

Sometimes, using different orders of adding may yield sums that might differ by 1 dB, but this is not too significant a difference in acoustics. In general, the above simplified summation procedure will yield accurate sums to the nearest 1 dB. This degree of accuracy is considered acceptable in the material given in this article.

Appendix C

BAC Sound Evaluation Worksheet

Job Name _____

Date _____

Address _____

Engineer _____

Architect _____

BAC Model _____

Steps	Items	Center Frequency - Hz							
		63	125	250	500	1000	2000	4000	8000
Noise criterion	1. Determine appropriate "NC" Criterion for neighbor activity from Table 2								
	2. Insert sound pressure levels (Lp) for selected "NC" Criterion. (Obtain values from Figure 1 or Table 1)								
	3. Tabulate sound reduction provided by wall construction. (Obtain values from Table 3)								
	4. Establish tentative outdoor Noise Criterion for the unit. (Item 2 plus Item 3)								
	5. List average minimum outdoor background sound levels. (measured or estimated from Figure 2 and Tables 4 and 5)								
	6. Set final outdoor background Noise Criterion. (High value, by octave band, of Items 4 and 5)								
Sound levels	7. Enter unit sound pressure level rating at 15 m.								
	8. Insert distance correction to adjust unit ratings to distance of _ m in direction toward critical neighbor. (For distance greater than 15 m use Table 6; for distances less than 15 m use Table 7)								
	9. Establish outdoor unit Lp at neighbor location. (Item 7 minus Item 8 for distances greater than 15 m. Item 7 plus Item 8 for distances less than 15 m.								
	10. Apply reflection adjustment to meet condition existing at unit site. Refer to Figures 3 and 4 for effect of reflecting walls; or add 5 dB for close-in build up of noise; 0 dB if no reflection effects.								
	11. Tabulate resultant unit Lp at critical neighbor location. (Item 9 plus Item 10)								
Comparison, Criteria vc Levels	12. Copy Item 6 levels from above. This is the outdoor noise criterion for the critical neighbor.								
	13. Ascertain tentative sound reduction required for unit. (Item 11 minus Item 12. Insert "0" for negative values)								
	14. Apply judgement factor. (For conservative approach, use "0" in all bands. To permit unit noise to exceed background levels slightly, insert "5")								
	15. Tabulate final sound reduction requirement for the job. (Item 13 minus item 14)								
	16. Indicate estimated or rated attenuation of all sound reduction treatment if used. (Should at least equal Item 15)								





BALTIMORE AIRCOIL COMPANY



WWW.BALTIMOREAIRCOIL.EU



BALTIMORE AIRCOIL INTERNATIONAL NV



BALTIMORE AIRCOIL INTERNATIONAL NV



@BALTIMOREAIRCOILEUROPE



BACEUROPE

Read more on [BAC's sound expertise:](#)

